

1710-0 POP UP T-HANDLE COMPRESSION LATCH

Ø 5.5MM THROUGH HOLES

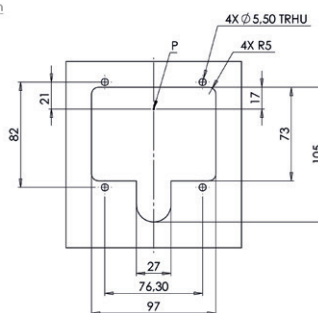

IP65

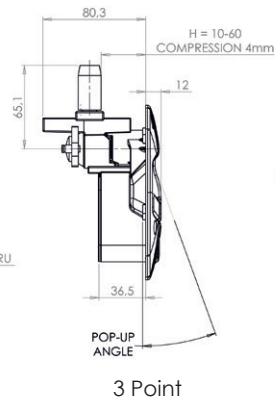
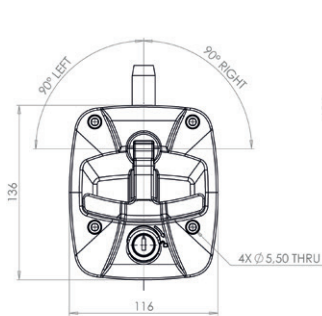
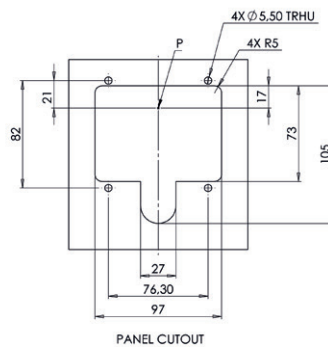
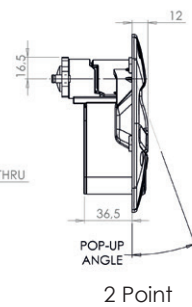
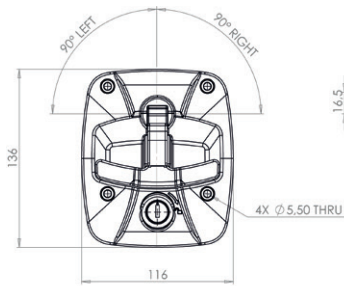
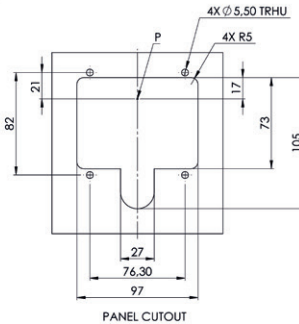
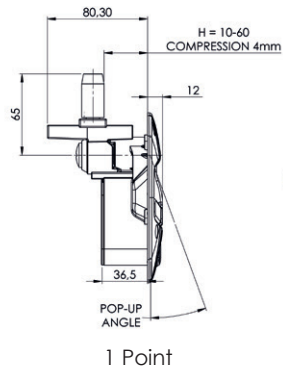
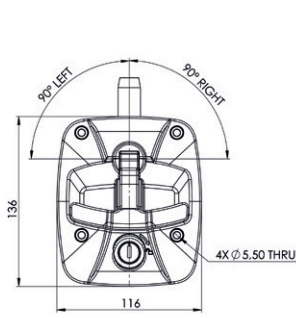

Range Overview

Model No.	Cylinder Type	Control Type
1710-11200-20	CH751 Locking (Keyed 805 available)	1 Point
1710-12200-20		2 Point
1710-13200-20		3 Point

Product Overview

Cylinder Type	CH751 Locking (2 Keys Supplied)
IP Rating	IP65
Opening	Left or Right (180°)
Panel Thickness	1 - 10mm
Grip Range	10 - 60mm
Mounting Style	Ø 5.5mm Through Holes
Cam Option	Cam Supplied

Parts Specifications

Section	Material
Body	Black PA6+30%GF Plastic
Handle	Black PA6+30%GF Plastic (Stainless Steel available)
Shaft	Stainless Steel
Cylinder	Stainless Steel

Can be installed indoors or outdoors, with an IP rating of IP65 thanks to the dust and water resistant seal.